



Dimensioni: 160x25,5mm
Peso: Kg 15,40 m²



COLORI

MARRONE SCURO



GRIGIO



MARRONE CHIARO





RESISTENTE



RESISTENTE ALL'ACQUA



RESISTENTE ALLE MACCHIE



FACILE E VELOCE INSTALLAZIONE



VERSATILE



FACILE MANUTENZIONE

ACCESSORI

IMMAGINE	ARTICOLO N°	DESCRIZIONE
	ST13L16	CLIP DI ALLUMINIO
	STGJ86	BPC CO-ESTRUSO CON CAPSULA PROTETTIVA
	PRO CO	PROFILO FINITURA mm 40 x 50 misura esterna spessore 5 mm



1. Fissate la sottostruttura, preferibilmente in legno o alluminio, al muro con un appropriato sistema di fissaggio. La sottostruttura deve avere uno spessore minimo di 2 cm: Rivesti non può essere appoggiato direttamente al muro. L'interasse della sottostruttura deve essere max 40 cm. Assicuratevi che ci sia allineamento orizzontale e verticale. Fissate la prima asta di Rivesti, usando la clip e le viti idonee al tipo di sottostruttura, ad almeno 2 cm dal terreno sia in posa orizzontale che verticale per evitare assorbimenti di acqua /umidità.

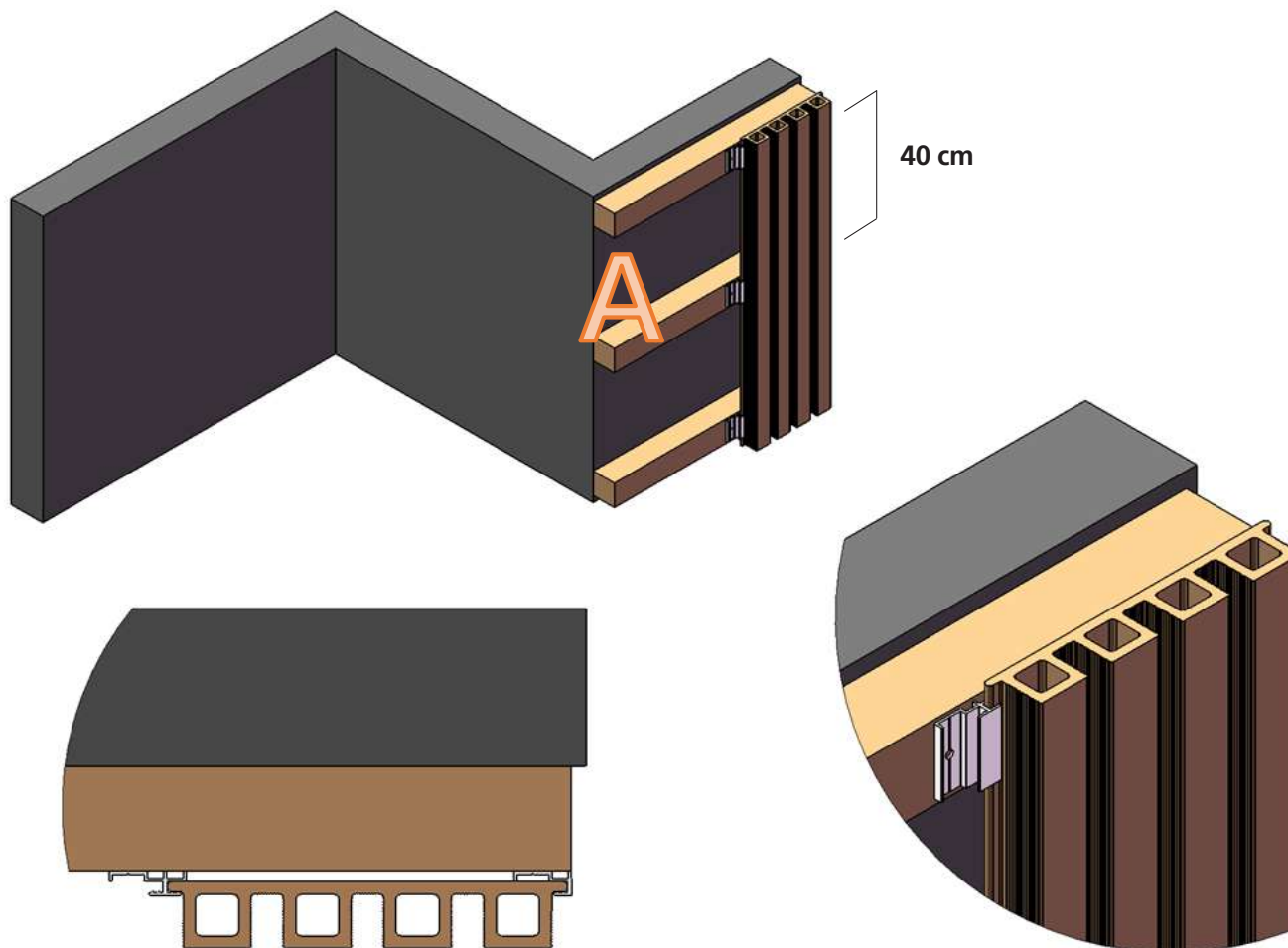

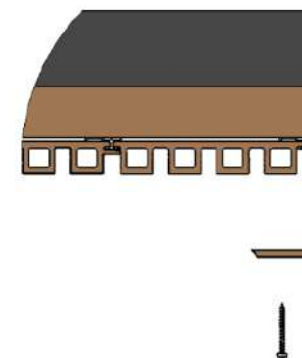
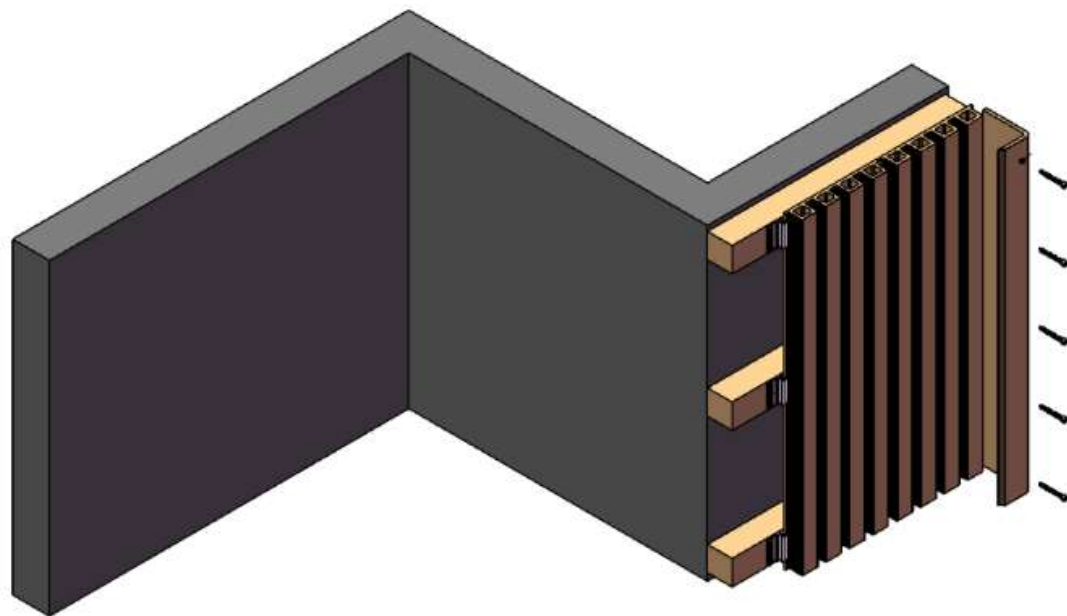

2. Installate il profilo di finitura avvitando direttamente.

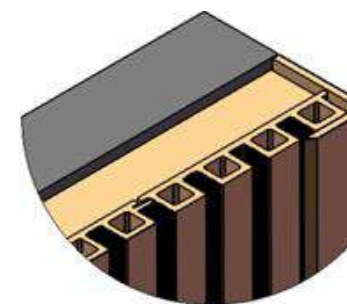

TIMBY

3. Per l'angolo esterno, l'ultima tavola di RIVESTI dovrebbe essere fissata con viti direttamente mettendo un fissa-spazio dietro. Installare la prima asta del pezzo B usando lo stesso schema del punto 2.

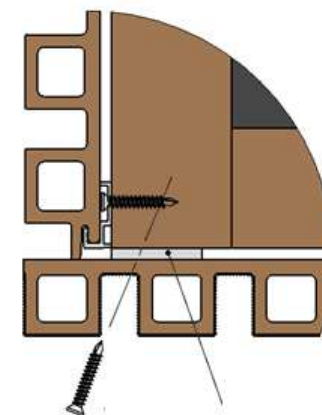
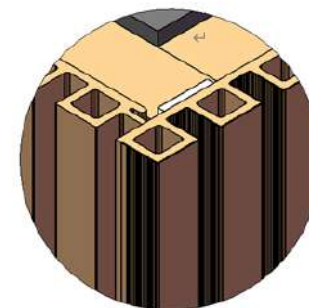
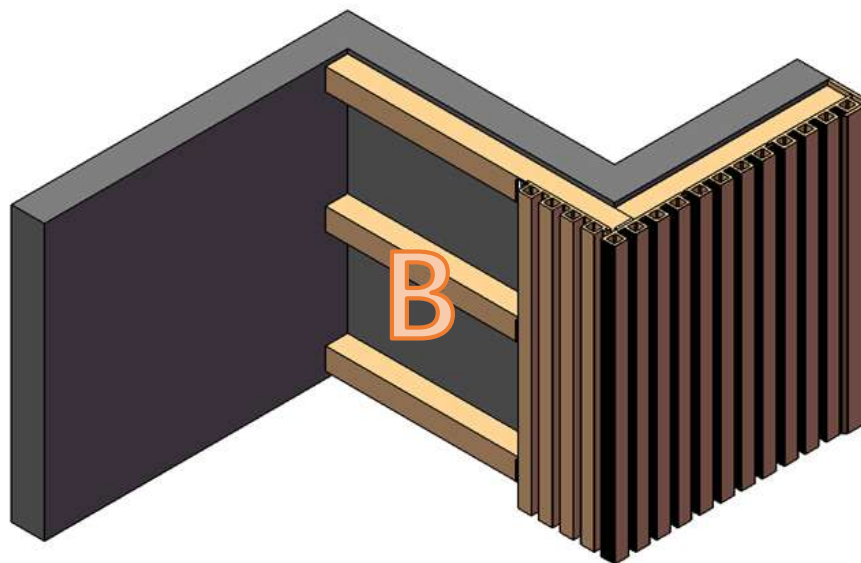

FISSA-SPAZIO

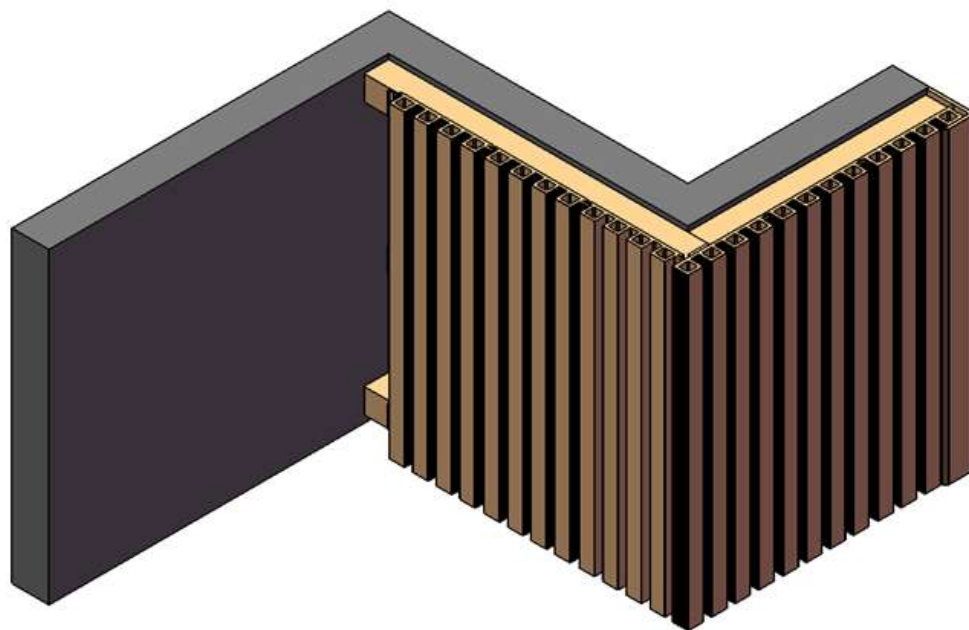

4. Installare tutto il lato B.

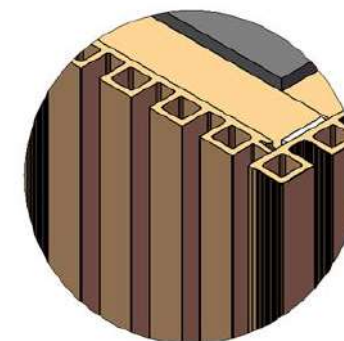
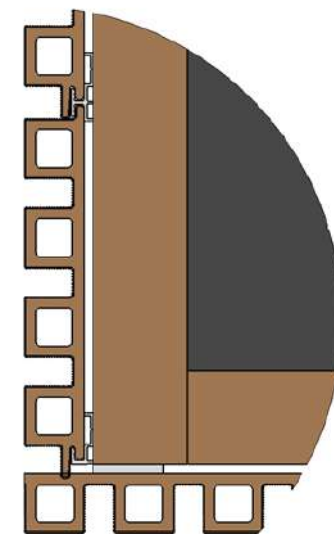

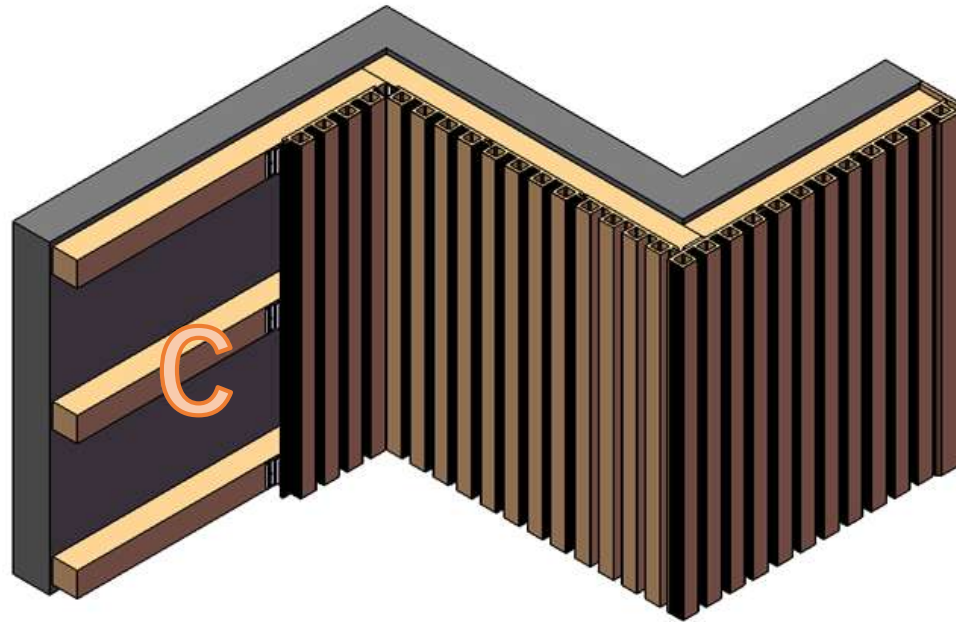

Per l'angolo interno, l'ultima asta di RIVESTI dello spazio B dovrebbe essere installata con una clip.
La prima asta dello spazio C dovrebbe essere installata come il punto 2.

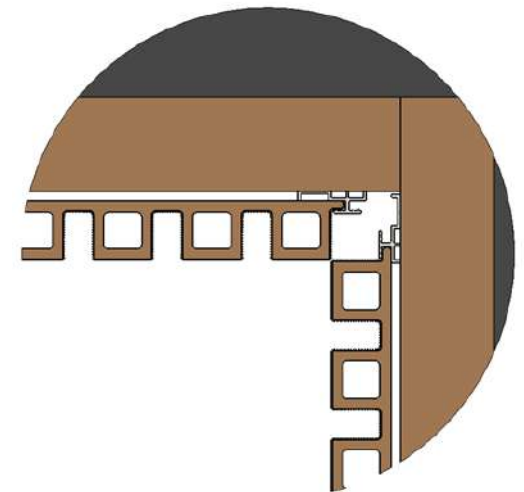
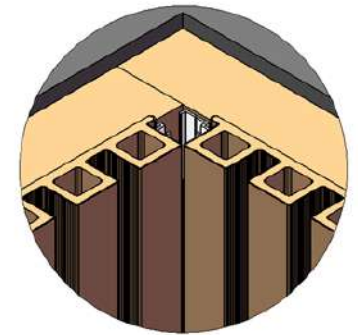

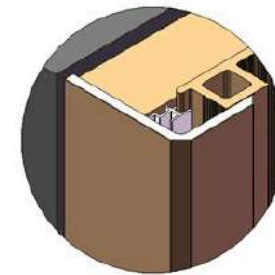
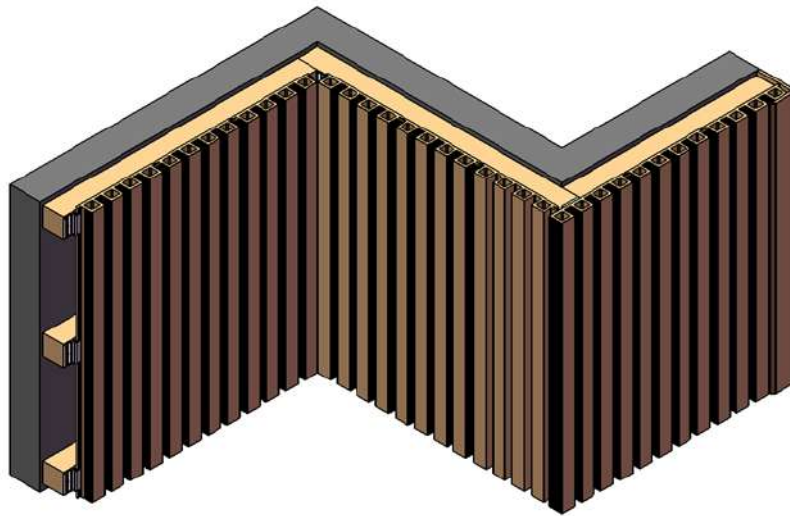

6. Dopo aver finito lo spazio C, avvitare la parte finale per la rifinitura

7. IMPORTANTE

- come tutti i prodotti con contenuto vinilico RIVESTI dilata, va lasciato uno spazio di min 3 mm tra una asta e l'altra in lunghezza.
- evitare la installazione in locali con fonti di calore eccessive.
- per eventuali finiture superiori o particolari rivolgersi al Vs. lattoniere di fiducia

